



# AWTC60WP HD Camera

## USER MANUAL

ISSUED OCTOBER 2018

### **⚠ WARNING**

Failure to follow all instructions and safety precautions in this manual, in the vehicle and body manufacturers' manuals and on the safety decals attached to the vehicle, body and this product could result in serious injury or death to operators, service technicians or bystanders and/or damage to property.

DO NOT operate the vehicle or install this product before you READ and UNDERSTAND the vehicle Operation Manual, this manual and other applicable manufacturers' manuals, and all safety decals. This product must be installed by certified technicians/installers familiar with the vehicles on which they will be making the installation.

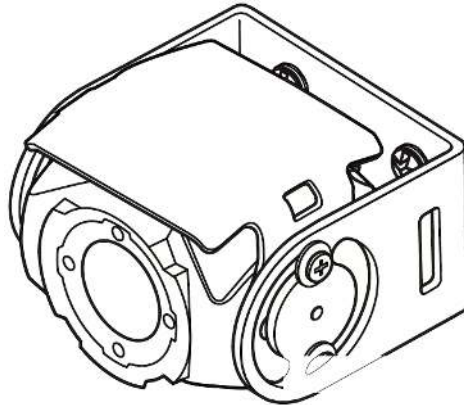

# TABLE OF CONTENTS

## Camera

AWTC60WP .....	3
Precautions .....	4
Camera Cable Pin Function .....	5
DIN Pin Waterproof Assurance .....	6
How to Connect the Cable .....	7
Features and Specification .....	8
Installation .....	10
Dimensions .....	13
<b>Index</b> .....	<b>14</b>

## SAFETY PRECAUTIONS

### Federal Communications Commission (FCC) Statement

This Equipment has been tested and found to comply with the limits for a Class B digital device, pursuant to Part 15 of the FCC rules. These limits are designed to provide reasonable protection against harmful interference in a residential installation. This equipment generates, uses and can radiate radio frequency energy and, if not installed and used in accordance with the instructions, may cause harmful interference to radio communications. However, there is no guarantee that interference will not occur in a particular installation. If this equipment does cause harmful interference to radio or television reception, which can be determined by turning the equipment off and on, the user is encouraged to try to correct the interference by one or more of the following measures:

- Reorient or relocate the receiving antenna.
- Increase the separation between the equipment and receiver.
- Connect the equipment into an outlet on a circuit different from that to which the receiver is connected.
- Consult the dealer or an experienced radio / TV technician for help.

You are cautioned that changes or modifications not expressly approved by the party responsible for compliance could void your authority to operate the equipment.

## **NOTICE**

---

This device complies with Part 15 of the FCC Rules. Operation is subject to the following two conditions:

1. This device may not cause harmful interference and,
  2. This device must accept any interference received, including interference that may cause undesired operation
-

## PRODUCT DOCUMENTATION UPDATES

Thank you for purchasing our product. Please read this User Manual before using the product. All product documentation is subject to change without notice. Please go to [www.3rdeyecam.com](http://www.3rdeyecam.com) to get the most current documentation for your 3rd Eye products.



**USER MANUAL**  
**AWTC60WP**

**AWTC60WP HD CAMERA**  
**COLOR CAMERA**

**USER MANUAL**  
**ISSUED OCTOBER 2018**  
**3E-AWTC60WP-UM-1018**

# USER MANUAL

## AWTC60WP

### PRECAUTIONS

Before attempting to hook up and operate, please read this manual.

1. To reduce the risk of electronic shock, do not remove cover or back. No user serviceable parts inside. Refer servicing to qualified service personnel.
2. Never point the camera toward the sun. It should not expose the lens directly to sun or strong light as this may damage the pick-up device.
3. Handle this camera with care. Avoid severe shock or impact to the camera as it contains sensitive parts which can be damaged by improper handling.
4. The allowance temperature range for operation of this camera is between -20 to 65° (-4 to 146°F) and the allowable humidity is 85% maximum. If the camera is to be placed in an extremely dusty location, a special housing may be necessary to protect the camera and lens.

# USER MANUAL

## AWTC60WP

### CAMERA CABLE PIN FUNCTION

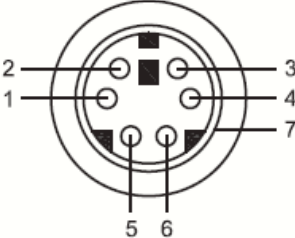

1	Video
2	GND (OPTION)
3	N/A
4	Power
5	GND
6	GND
7	Shield GND

# USER MANUAL

## AWTC60WP

### DIN PIN WATERPROOF ASSURANCE

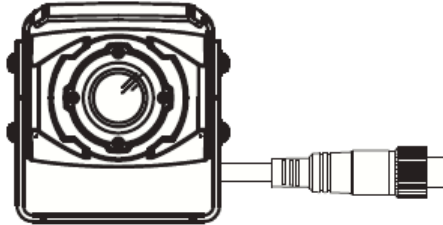

CAMERA

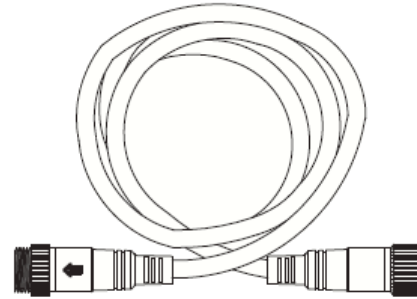

EXTENSION CABLE

**NOTE:** Wrap the whole cable connection from one end to another end with the Weather-Sealer Strip (NOT SUPPLIED) to ensure adequate insulation against water.



# USER MANUAL

## AWTC60WP

### HOW TO CONNECT THE CABLE

Follow the instructions below when connecting the cable and camera.

#### STEP 1:

Line up the position marks on the male connector and female connector as shown in image below.

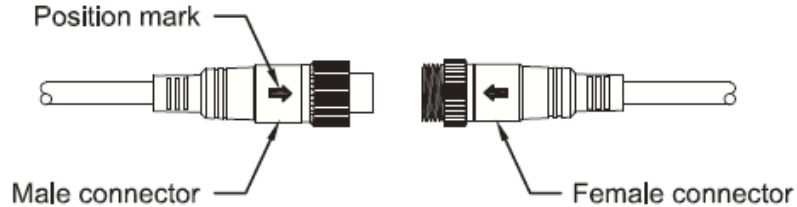

#### STEP 2:

Rotate the ring on the male connector by hand as shown in image below.

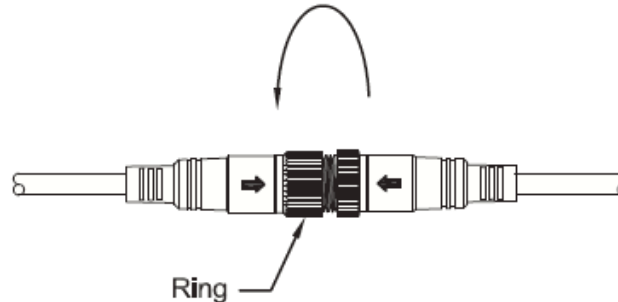

#### STEP 3:

Then screw in securely to the threads on the female connector.

# USER MANUAL

## AWTC60WP

### FEATURES AND SPECIFICATIONS

#### A. Key Features

- 1/3" color CMOS sensor
- Electronic auto iris control
- AWB(Auto White Balance)
- Back light compensation (BLC on)
- IP 69K
- 10G shock/vibration
- G-Force Rating : 30
- Isolated ground
- Automatic heater
- Double window glasses & replaceable outer glass

#### B. Optical

- Lens : F=2.9 H:96° V:72° Diagonal 120°

# USER MANUAL

## AWTC60WP

### FEATURES AND SPECIFICATIONS (CONTINUED)

#### C. Specification Electrical

- Signal Format : NTSC
- Image Device : 1/3" color CMOS sensor
- Picture Element : 720 x 480 NTSC
- Synchronization : Internal SYNC.
- Resolution : 420 TV lines
- S/N Ratio : More than 45d B
- Video Out : 75 Ohm 1Vp-p composite Signal
- IRIS: Electronic Auto IRIS System
- Operating Voltage Range : 9V-15V

#### D. General

- Operating Temperature : -40°C - 65°C (with Heat)

#### E. Accessories

- Supplied Accessories : Mounting Bracket & Screw Kits, Sun Shield

# USER MANUAL

## AWTC60WP

### INSTALLATION

When mounting the camera, proceed as follows:

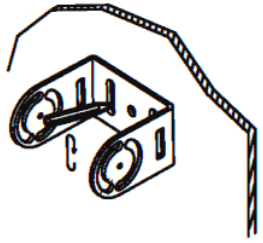
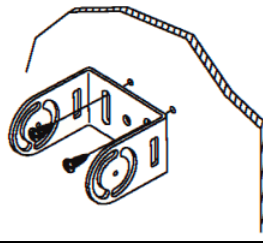
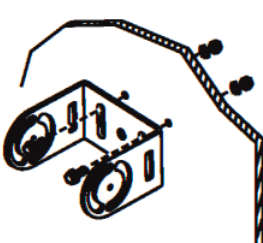
<p><b>STEP 1:</b></p> <p>Hold the camera on the chosen location and mark at least two different points for the drill holes.</p>	
<p><b>STEP 2:</b></p> <p>When fastening with self-tapping screws, drill 0 5.5 mm holes at the points you have just marked.</p>	
<p><b>STEP 3:</b></p> <p>Screw the camera bracket on with the 6 x 20 mm self-tapping screws.</p>	
<p><b>STEP 4:</b></p> <p>When attaching with threaded screws, drill 6.5 mm holes at the points you have just marked.</p>	

# USER MANUAL

## AWTC60WP

### INSTALLATION

When mounting the camera, proceed as follows:

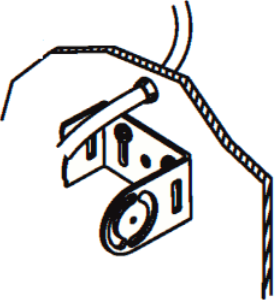
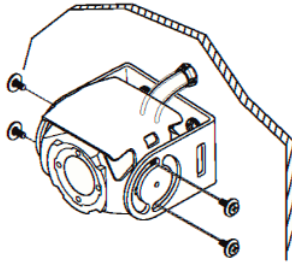
<p><b>STEP 5:</b> Screw the camera bracket on with the M6 x 20 mm threaded screws.</p>	
<p><b>STEP 6:</b> Creating a through-hole for the camera connection cable, drill a hole of 16mm near the camera.</p>	
<p><b>STEP 7:</b> Mount the camera by pushing the camera into the camera bracket.</p>	
<p><b>STEP 8:</b> Attach the camera loosely with the 4 screws M3 x 10 mm in the slots.</p>	

# USER MANUAL

## AWTC60WP

### INSTALLATION

When mounting the camera, proceed as follows:

#### **STEP 9:**

Tighten the 4 screws in the slots of the camera bracket.

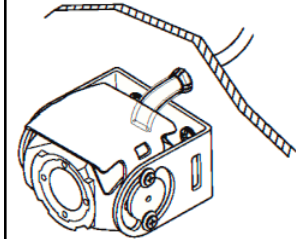

**NOTE:** This camera is set to mirror for default. If need to change, please adjust it from your monitor.

# USER MANUAL

## AWTC60WP

### DIMENSIONS

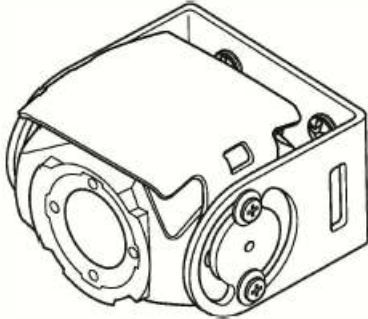
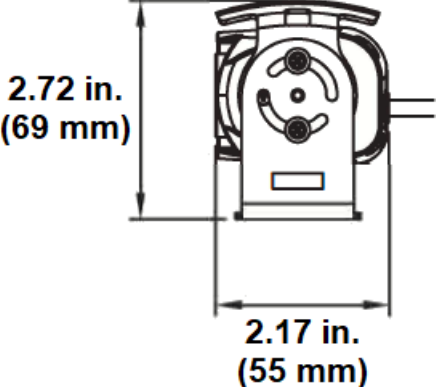

## C

camera cable pin function 5

## D

dimensions 13

DIN pin waterproof assurance 6

## F

features and specifications 8

## H

how to connect the cable 7

## I

installation 10

## P

precautions 4



# 3RD EYE WARRANTY

## 3RD EYE PRODUCTS LIMITED WARRANTY

3rd Eye warrants that the 3rd Eye Hardware and Software, as delivered by 3rd Eye to Client, will be free from defects in materials and workmanship in accordance to the terms and conditions specified herein. This warranty is a "parts replacement only" policy, and does not cover labor. Other limitations apply as provided below.

## TERMS & CONDITIONS

### DEFINITIONS

- 1.1 "Hardware" means cameras, monitors, Gateway and related peripheral hardware.
- 1.2 "Software" shall mean the Application or Embedded Software.
- 1.3 "Self-Service Client" shall mean any client that maintains their own equipment and is not under Service Agreement with 3rd Eye.

### WARRANTY PERIOD

- 2.1 Unless a separate written Agreement with 3rd Eye is provided, a 1 Year warranty from the original date of hardware installation or the original date of purchase, whichever occurs first shall apply. Troubleshooting, labor, travel time, freight and miscellaneous costs are not covered.
- 2.2 New replacement hardware covered under warranty shall be covered under warranty for the remaining period of the initial warranty term.
- 2.4 Refurbished hardware and hardware installed by the customer shall carry a 90-day replacement warranty from the original date of hardware installation or the original date of purchase, whichever occurs first shall apply.
- 2.5 Labor and workmanship provided by a certified 3rd Eye technician shall carry a 90-day replacement warranty from the original date of service.

### WARRANTY REIMBURSEMENT

- 3.1 To submit for warranty reimbursement, Client must notify 3rd Eye in writing by obtaining a 3rd Eye Return Material Authorization (RMA) number within the relevant Warranty Period. The authorized RMA the Client receives must be marked on the outside of the package returning the failed component and sent prepaid and packaged appropriately for safe shipment. The RMA number will serve as the warranty claim reference number. 3rd Eye will either repair or replace the defective component at its discretion. To request for an RMA number please complete the online RMA form found at [www.3rdEyecam.com](http://www.3rdEyecam.com) or call 866.804.2984.
- 3.2 If the failure analysis of the returned hardware determines the cause of failure was other than material or workmanship covered under the terms of this limited warranty, the CUSTOMER agrees to pay 3rd Eye Cam for the replacement hardware, labor and expenses.

### WARRANTY DISCLAIMER

- 4.1 This warranty shall become null, void, and not apply if Client fails to notify 3rd Eye in writing of such defects prior to the expiration of the Warranty Period, if the defect is not reproducible, or if the defect is caused by (a) customer damage, negligence, misuse, tampering, accident, fire, variation or interruption of electricity; (b) failure by Client to properly install, maintain, or use the 3rd Eye Hardware or the Third Party Hardware; (c) alterations made by anyone other than 3rd Eye to the 3rd Eye Hardware or the hardware and/or software that interfaces with the 3rd Eye Hardware after installation; (d) any attempt to service the 3rd Eye Hardware other than by 3rd Eye's service technicians or (e) any hardware, software or part not approved by or not supplied by 3rd Eye. 3rd Eye shall not be responsible for the safeguarding or retention of Client's or any third-party software, firmware, information or memory data contained in, stored on, or integrated with any 3rd Eye Hardware that is returned to 3rd Eye pursuant to any warranty provided under this Agreement.
- 4.2 3rd Eye hereby disclaims all warranties, express, implied, or statutory, including, without limitation, the warranties of merchantability, fitness for a particular purpose. 3rd Eye makes no claim that the software will work in combination with any hardware or software products provided by third parties, that the operation of the software will be uninterrupted or error-free, that all defects in the software can be corrected, or that any specific result or outcome will be achieved by utilizing the products or third-party hardware provided by 3rd Eye.



a **DOVER** company

[www.3rdeyecam.com](http://www.3rdeyecam.com)

Customer Care:  
866-804-2984

3rd Eye  
22130 Merchants Way STE 100  
Katy, TX 77449